



RDX33.21, RDX43.2

Room temperature controllers with LCD and 7-day time switch

RDX33..
RDX43..

For release of a heat pump or control of actuating devices in heating or cooling mode

-
- **Operating modes: Auto Timer, Comfort, Energy Saving, and Protection**
 - **Potential-free output (ON / OFF) for release of a heat pump or control of actuating devices**
 - **Potential-free output (ON / OFF) for selection of heating or cooling**
 - **Output for control of auxiliary electric heating (RDX43.2)**
 - **Manual heating / cooling changeover**
 - **8 programmable time switches**
 - **Selectable commissioning and control parameters**
 - **Selectable display of room temperature or setpoint**
 - **Minimum and maximum setpoint limitation**
 - **Operating voltage: Batteries DC 3 V (RDX33.21)**
AC 230 V (RDX43.2)

Use



For control of the room temperature in individual rooms or zones that are heated or cooled by a heat pump or via actuating devices.

The room temperature controller...

- controls release of the heat pump's compressor or actuating devices
- switches an auxiliary electric heater

Suited for systems with manual H/C changeover.

Functions

- Manual H/C changeover by pressing the respective button 
- Room temperature control with built-in sensor
- Selection of operating mode via button 
- Auto Timer mode with 8 programmable time switches for changeover between Comfort mode and Energy Saving mode
- Outputs for release of heat pump and for control of actuating devices in heating or cooling mode (ON / OFF). Output for auxiliary electric heater

Controller



Temperature control

The controller acquires the room temperature via its built-in sensor and maintains it at the adjusted setpoint.

The switching differential is 2 K in heating mode and 1 K in cooling mode (adjustable via parameters P08 and P09).

Display

The display shows the acquired room temperature or the setpoint of the current operating mode. This can be selected via parameter P15. Factory setting is display of the current room temperature.

The heating  and cooling  symbols on the display show the system's operating state. Symbol  shows when the auxiliary electric heater is in operation.





Symbol  indicates when the heat pump's compressor is on.

If required, room temperature and setpoint can also be displayed in °F in place of °C. This is made by changing parameter P14.



Operating modes

Auto Timer mode

The following operating modes are available by pressing the respective button:

In Auto Timer mode , the controller switches automatically between Comfort mode and Energy Saving mode according to the 8 programmed time switches. The controller displays the symbol of Auto Timer mode  and that of the current operating mode, either Comfort mode  or Energy Saving mode .

Comfort mode

In Comfort mode , the controller maintains the setpoint, which can be adjusted via the  buttons.

Energy saving tip Setpoint limitation

For energy saving purposes, the setpoint setting range can be limited to a minimum (parameter P05) and a maximum (parameter P06).

P05 < P06

- If the minimum limit P05 is set lower than the maximum limit P06, both heating and cooling are adjustable between these 2 limits.

P05 ≥ P06

- For heating or cooling applications:
 - The setting range in cooling mode is from P05...40 °C instead of 5...40 °C
 - The setting range in heating mode is from 5...P06 °C instead of 5...40 °C

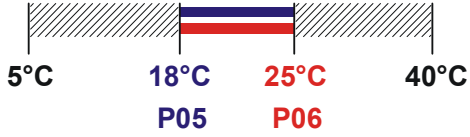
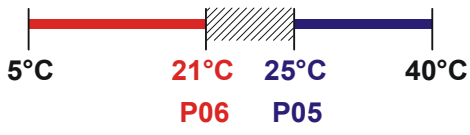
Examples	Heating or cooling
P05 < P06	 <p data-bbox="874 465 1345 544">5°C 18°C 25°C 40°C P05 P06</p> <p data-bbox="895 562 1324 622">Cooling setpoint adjustable 18...25 °C Heating setpoint adjustable 18...25 °C</p>
P05 ≥ P06	 <p data-bbox="874 712 1345 790">5°C 21°C 25°C 40°C P06 P05</p> <p data-bbox="895 801 1324 864">Cooling setpoint adjustable 25...40 °C Heating setpoint adjustable 5...21 °C</p>

Energy Saving mode

The setpoints for Energy Saving mode (C) can be adjusted via control parameters P01 and P02.

Protection mode

In Protection mode (D), the controller monitors the setpoints adjusted for heating and cooling. If the room temperature exceeds or falls below the setpoint, the setpoint for Protection is maintained (this independent of the manual H/C changeover status). These setpoints can be adjusted via control parameters P03 and P04. The factory setting for heating in Protection mode is 8 °C.

Application with heat pump for heating or cooling:

Heating mode
(Q21-Q22 contact open)

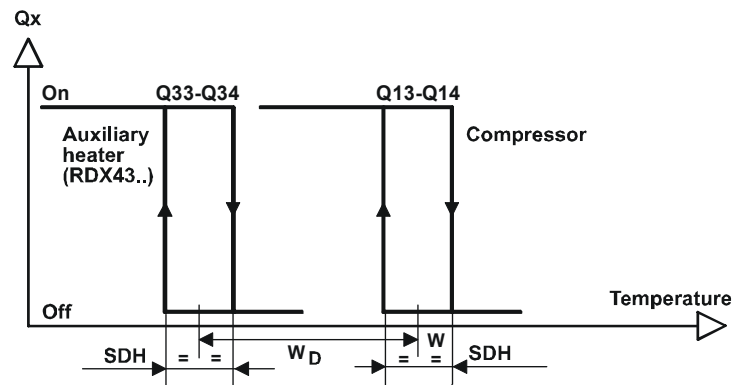

Cooling mode
(Q21-Q22 contact closed)

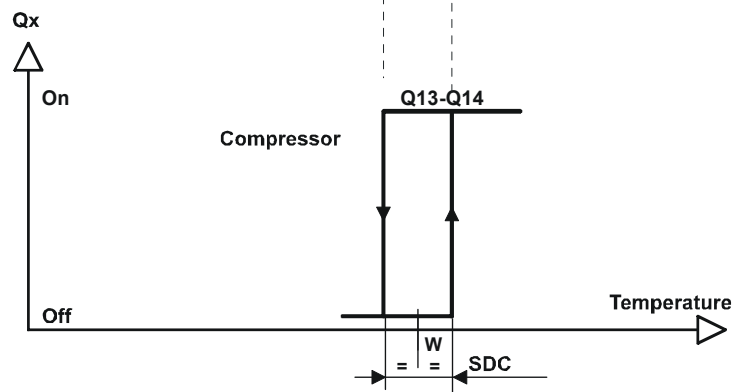

Legend

- W Room temperature setpoint
- W_D Switching differential between heating and auxiliary electric heating
- SDH Switching differential heating
- SDC Switching differential cooling

When used in connection with a heat pump, output Q13-Q14 (NO contact) must be connected to the compressor's control input. Output Q21-Q22-Q24 must be connected to the compressor's H/C control input. Output Q33-Q34 (NO contact) is for connection to an auxiliary electric heater (RDX43.2).

Heating / cooling mode

Button  is used for manual changeover from heating to cooling, or vice versa. The factory setting of the changeover contact is "Open" for heating and can be changed to "Closed" for heating using parameter P18.

Compressor on time

To avoid damage to the compressor during H/C changeover, a minimum compressor on / off time can be adjusted via parameters P11 and P12. The factory setting for the minimum on time is 1 minute and for the minimum off time 3 minutes.

Auxiliary electric heater
RDX43.2

Output Q33-Q34 is for connection to the auxiliary electric heater which is only available in heating mode, provided parameter P16 is set to 1 (enable). The minimum on time can be changed via parameter P13 (factory setting is 1 minute).

Auto Timer mode

The controller provides an Auto Timer mode with 8 programmable time switches. Each time switch can be assigned one or several days. In this mode, the controller switches automatically between Comfort mode and Energy Saving mode according to the programmed time switches.

Auto timer in Comfort mode



Auto timer in Energy Saving mode



Setting the time switches

Each time switch has a start time and end time for Comfort mode which can be applied to several weekdays.

To set the time schedule, keep button depressed for 3 seconds to go to the programmable timer setting mode. This mode is indicated by displaying Ax (x = auto timer 1...8) and the time of day --:-- blinking.



For each time switch, proceed as follows:

1. Symbols and are displayed. Press or to set the Comfort mode start time and confirm by pressing .

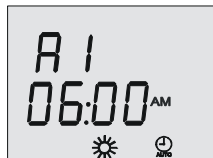

2. Symbols and are displayed. Press or to set the start time for Comfort mode or Energy Saving mode and confirm by pressing .

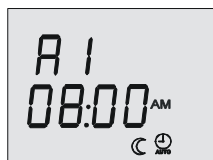

3. Symbol will flash. Press to select or to deselect each day and advance to the next day. Confirm setting for actual timer by pressing and advance to the next timer.



The controller leaves the programmable time switch setting mode if no button is pressed within 20 seconds. All changes made after the last press of will not be saved.

Viewing the time switches
Factory settings of time switches

Press to sequentially review the 8 time switches.

Time switches A1...A4 have the following factory settings:

Day(s)	Times of day when controller is in Comfort mode	
Mo (1) – Fr (5)	06:30 – 08:30 (A1)	17:30 – 22:30 (A2)
Sa (6)	08:00 – 23:00 (A3)	
So (7)	08:00 – 22:30 (A4)	
	- During remaining times, controller is in Energy Saving mode - Time switches A5...A8 are free (no factory settings made)	

Retrieving the factory settings

The settings of the time switches can be changed to suit individual needs. The factory settings can be retrieved any time:

1. Set the controller to Protection mode .
2. Press and simultaneously for 3 seconds. Release the buttons and, within 2 seconds, press 2 times.

The display shows “8888” during this process.

Overlapping of time switch sequences

In the second case, or when several time switch sequences overlap, the resulting output is the OR combination of the Comfort mode time of all time switches.

7-day time switch

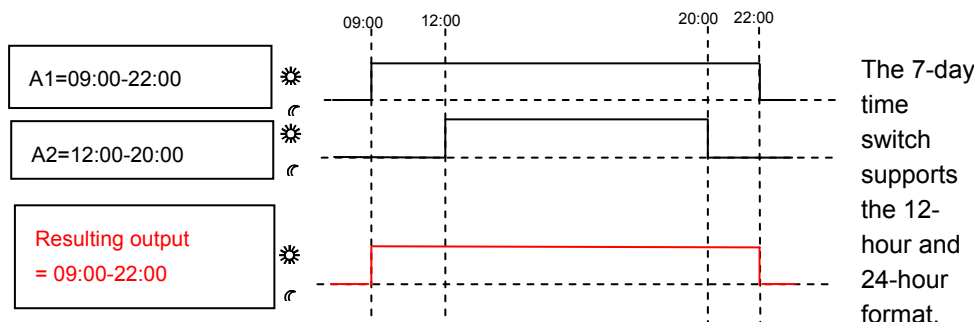

Parameter P17 = 0 (12 h) or = 1 (24 = factory setting).

Setting the clock

1. Keep the button depressed until the time digits start blinking. Press or to set the time of day.
2. Confirm the time of day by pressing and the weekday indicator starts blinking.
3. Press or to set the current weekday.
4. Confirm by pressing .

Power failure

In the event of a power failure, the time, date, last operating mode, last heating/cooling changeover status, setpoint and auto timer program will be stored. When power returns, this time reappears and starts running again. The time display blinks to indicate that there was a power failure. Blinking stops when the time and the day are confirmed by pressing , or when the time is readjusted by following the above procedure.

Symbol “low battery”

Replace / remove battery when the “low battery” symbol is activated. The time, date, last operating mode, last heating/cooling changeover status, setpoint and auto timer program will be stored.

Error handling

Temperature out of measuring range

If the room temperature is out of the measuring range (above 50 °C or below 0 °C), the display shows the limiting temperature in blinking figures (e.g. 50 °C or 0 °C).

Failure of built-in sensor







Should the built-in sensor become defective, the display will show “Err” blinking to draw the user’s attention.

Control parameters





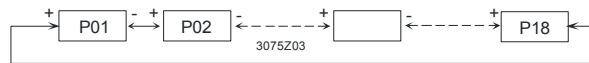

A number of control parameters can be readjusted to optimize the control performance. These parameters can also be set during operation without opening the unit. In the event of power failure, all control parameter settings will be maintained.

Parameter settings

The parameters can be changed as follows:



1. Set the controller to Protection mode .
2. Press  and  simultaneously for 3 seconds. Release the buttons and, within 2 seconds, press  again for 3 seconds. The display will show "P01".
3. Select the required parameter by repeatedly pressing  and .



4. By pressing  and  simultaneously, or by pressing , the current value of the selected parameter appears, which can be changed by repeatedly pressing  or .
5. 5 seconds after the last press of a button, or by pressing  and  simultaneously, the value will be stored.
6. If you wish to display and change additional parameters, repeat steps 3 through 5.
7. 10 seconds after the last display or setting, all changes will be stored and the controller returns to Protection mode.

Parameter reset

The factory setting of the control parameters can be retrieved as follows:

1. Set the controller to Protection mode .
2. Press  and  simultaneously for 3 seconds.

Release the buttons and, within 2 seconds, press the operating mode button 2 times.



The display shows "8888" during this process.

Control parameters for RDX33.21 and RDX43.2

Parameter		Factory setting	Setting range in increments of ..K/..min	RDX33	RDX43
P01	Setpoint for heating in Energy Saving mode C (W heat _{Eco})	16	OFF, 5 °C...W cool _{Eco} , 0.5 K		
P02	Setpoint for cooling in Energy Saving mode C (W cool _{Eco})	28	OFF, W heat _{Eco} ...40 °C, 0.5 K		
P03*	Setpoint for heating in Protection mode C (W heat _{PROT.})	8 °C	OFF, 5 °C...W cool _{PROT.} , 0.5 K		
P04*	Setpoint for cooling in Protection mode C (W cool _{PROT.})	OFF	OFF, W heat _{PROT.} ...40 °C, 0.5 K		
P05	Min. setpoint limitation in Comfort mode C (W min _{Comf.})	5 °C	5...40 °C, 0.5 K		
P06	Max. setpoint limitation in Comfort mode C (W max _{Comf.})	35 °C	5...40 °C, 0.5 K		
P07	Sensor calibration	0 K	-3...+3 K, 0.5 K		
P08	Switching differential in heating mode SDH	2 K	0.5...+4 K, 0.5 K		
P09	Switching differential in cooling mode SDC	1 K	0.5...+4 K, 0.5 K		
P10	Setpoint differential between heating and auxiliary heating W _D	2 K	0.5...+5 K, 0.5 K	X	
P11	Min. compressor on time (Q14)	1 min.	1...10 minutes, 1 min.		
P12	Min. compressor off time (Q14)	3 min.	1...10 minutes, 1 min.		
P13	Min. hold time of auxiliary heating	1 min.	1...10 minutes, 1 min.	X	
P14	Selection of °C or °F	°C	C or °F		
P15	Display of room temperature or setpoint	ON	OFF: Setpoint ON: Room temperature		
P16	Auxiliary heating in heating mode	1: Enable	0: Disable 1: Enable	X	
P17	12- or 24-hour format	1: 24 h	0: 12-hour format 1: 24-hour format		
P18	Acting direction of H/C changeover signal Q21-Q22	0:	0: Open (heating), closed (cooling) 1: Closed (heating), open (cooling)		

P03*/P04*: P04 is at least min. 5 K higher than P03

X	Not available
---	---------------

Type summary

Product No.	Features
RDX33.21	Room temperature controller with outputs for compressor and H/C changeover, operating voltage DC 3 V (battery-powered)
RDX43.2	Room temperature controller with outputs for compressor, H/C changeover and auxiliary electric heating, operating voltage AC 230 V

Equipment combinations

Description	Product No.	Data Sheet
Electromotoric 2-position valve with actuator	MVI.../MXI...	4867
Electromotoric 2-position actuator	SFA21...	4863
Thermal actuator (for TRVs)	STA21...	4893
Thermal actuator (for small valves 2.5 mm)	STP21...	4878

Accessories

Description	Product No.
Adapter plate 120 x 120 mm for recessed conduit boxes 4" x 4"	ARG70
Adapter plate 96 x 120 mm for recessed conduit boxes 2" x 4"	ARG70.1
Adapter plate 112 x 130 mm for surface wiring	ARG70.2

Ordering

When ordering, please give description and product No.:

E.g. **room temperature controller RDX33.21**

Valve actuators are to be ordered as separate items.

Mechanical design

The controller consists of 2 parts:

- Plastic housing which accommodates the electronics, the operating elements and the built-in room temperature sensor
- Mounting base

The housing engages in the mounting base and snaps on.



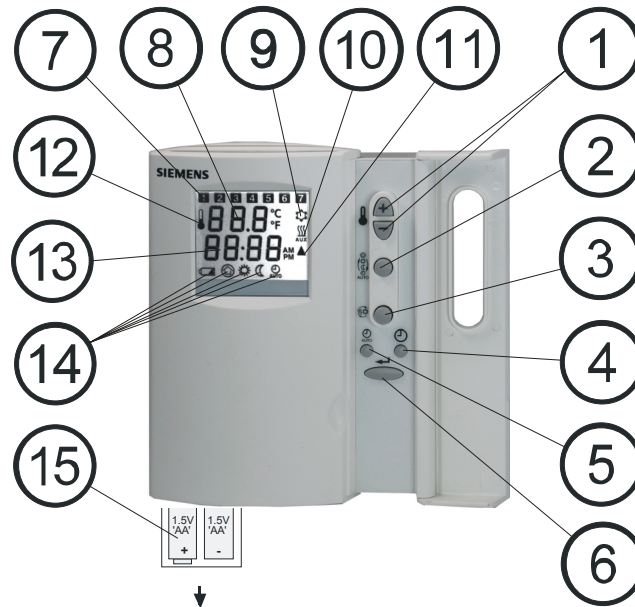

The base carries the screw terminals.

**Setting elements,
operating elements
and display**











Legend

Operating elements

- 1 Buttons + and - for adjusting the setpoints, the control parameters, the days of week, and the time of day
- 2 Button for selecting the mode of operation:
 -  Protection mode
 -  Comfort mode
 -  Energy Saving mode
 -  Auto Timer mode
- 3 Button for manual H/C changeover 
- 4 Button for time of day and weekday settings in automatic time switch program
- 5 Button for selecting and setting the 8 time switches
- 6 Button for confirmation

Display

- 7 Day of week 1...7 (1 = Monday / 7 = Sunday)
- 8 Current room temperature, room temperature setpoint in °C or °F
- 9 Cooling mode
- 10  Auxiliary electric heating ON
- 11  Compressor ON
- 12  Symbol for display of current room temperature
- 13 Time of day in hours and minutes (12- or 24-hour format)
- 14 Symbols:
 -  Battery exchange
 -  Protection mode
 -  Comfort mode
 -  Energy Saving mode
 -  Auto Timer mode
- 15 Battery compartment (only with RDX33.21)

Mounting and installation

The room temperature controller is to be mounted on a wall, not in niches or bookshelves and not behind curtains. Temperature acquisition must not be adversely affected by heat or cooling sources or direct solar radiation. Mounting height is about 1.5 m above the floor.

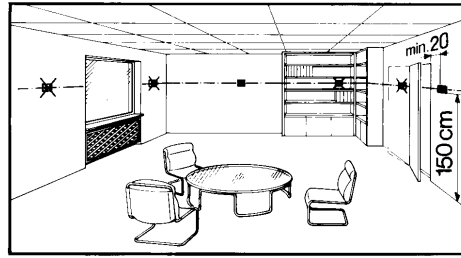

The controller can be fitted on a recessed conduit box.

Wiring



Also refer to Mounting Instructions M3075 enclosed with the controller.



- Wiring, fuse and earthing must be installed in compliance with local regulations. It must be made certain that safety extra low-voltage lines (SELV circuit) are clearly separated from AC 230 V mains voltage cable
- The cables to the controller carry AC 230 V mains voltage and must be appropriate sized
- The AC 230 V mains supply line must have an external fuse or circuit breaker with a rated current of no more than 10 A



Commissioning RDX33...

After wiring the base and attaching the controller to the base (see Mounting instructions), remove the battery compartment from the controller until the display is blank. The controller synchronizes its outputs as soon as the battery compartment is reinserted. Then, the controller is ready to be commissioned by qualified staff. The control parameters of the controller can be set to ensure optimum performance of the whole system (also refer to "Parameter settings").

Commissioning RDX43...

After applying power, the controller makes a reset during which all LCD segments blink, indicating that the reset has been correctly made. This takes about 3 seconds. Then, the controller is ready to be commissioned by qualified staff. The control parameters of the controller can be set to ensure optimum performance of the whole system (also refer to "Parameter settings").

Compressor-based application

- If the controller is used in conjunction with a compressor, the minimum on time (parameter P11) and off time (parameter P12) must be correctly adjusted in order not to adversely affect the compressor's service life

Sensor calibration

- If the room temperature displayed by the controller does not accord with the room temperature effectively measured, the temperature sensor can be recalibrated. In that case, parameter P07 must be changed

Setpoint and setting range limitation

- For comfort and energy saving reasons, it is recommended to check the setpoints and setpoint setting ranges (parameters P01...P06) and, if necessary, to change them accordingly

Technical data

⚠ Power supply	Operating voltage RDX33.21	DC 3 V Alkaline batteries AA 2 x 1.5 V
	Operating voltage RDX43.2	AC 230 V + 10/-15%
	Frequency Power consumption	50/60 Hz Max. 8 VA
Outputs	Control outputs RDX33.. Q13-Q14 Q21-Q22	AC 230 V / max. 4 A AC 24...230 V / max. 4 A or SELV DC min.5 V / 0.1 A max.30 V / 0.5 A
	⚠ The total of all output currents (on Q1x and Q2x) shall not exceed 5 A	
	Control outputs RDX43.. Q13-Q14 Q33-Q34 Q21-Q22-Q24	AC 230 V / max. 3 A AC 230 V / max. 3 A AC 24...230 V / max. 3 A or SELV DC min.5 V / 0.1 A max.30 V / 0.5 A
⚠ The total of all output currents (on Q1x, Q2x and Q3x) shall not exceed 4 A		
Sensor	Built-in room temperature sensor	NTC
Operational data	Switching differential (adjustable from 0.5...4 K)	
	Heating mode (factory setting)	2 K
	Cooling mode (factory setting)	1 K
	Setpoint setting range	
	☀ Comfort mode	5...40 °C
	☾ Energy Saving mode	OFF, 5...40 °C
	Ⓜ Protection mode	OFF, 5...40 °C
	Factory settings for setpoints	
	☀ Comfort mode	20 °C
	☾ Energy Saving mode H/C	16 °C / 28 °C
Ⓜ Protection mode (H/C mode)	8 °C	
Built-in room temperature sensor		
Measuring range	0...49 °C	
Accuracy at 25 °C	< ± 0.5 K	
Temperature calibration range (P07)	± 3.0 K	
Resolution of settings and display		
Setpoints	0.5 °C	
Display of current temperature	0.5 °C	
Environmental conditions	Operation	To IEC 721-3-3
	Climatic conditions	Klasse 3K5
	Temperature	0...50 °C
	Humidity	<95% r.h.
	Transport	To IEC 721-3-2
	Climatic conditions	Class 2K3
	Temperature	-25...60 °C
	Humidity	<95% r.h.
	Mechanical conditions	Class 2M2
	Storage	To IEC 721-3-1
Climatic conditions	Class 1K3	
Temperature	-25...60 °C	
Humidity	<95% r.h.	
Norms and standards	CE conformity to EMC directive	2004/108/EEC 2006/95/EEC

Low-voltage directive	
Product standards	
Automatic electrical controls for household and similar use	EN 60730 – 1
Special requirements for temperature-dependent controls	EN 60730 – 2 - 9
Electromagnetic compatibility	
Emissions	IEC/EN 61000-6-3
Immunity	IEC/EN 61000-6-2
Devices of safety class	II to EN 60730
Degree of pollution	Normal
Degree of protection of housing	IP30 to EN 60529
Connection terminals for	Solid wires or prepared stranded wires 2 x 0.4...1.5 mm ² or 1 x 2.5 mm ²
Weight	0.28 kg
Color of housing front	White, NCS S 0502-G (RAL 9003)

General

Connection terminals

RDX33.21

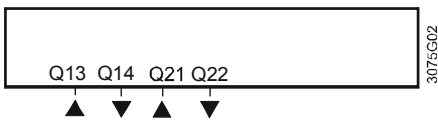

Q13-Q14 Control output (NO), compressor
Q21-Q22 Control output (NO), H/C changeover

RDX43.2

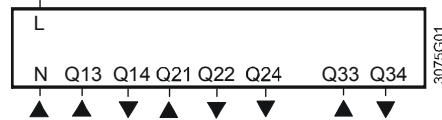

L, N Operating voltage AC 230 V
Q13-Q14 Control output (NO), compressor
Q21-Q22 Control output (NO), H/C changeover for heating
Q21-Q24 Control output (NO), H/C changeover for cooling
Q33-Q34 Control output (NO), auxiliary electric heater

Connection diagrams

Use: H/C with RDX33.21
Heat pump

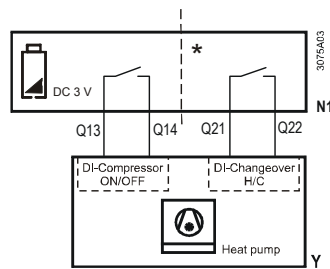

H/C with actuating devices

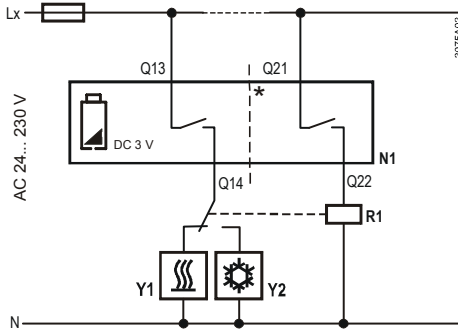

H/C plus auxiliary electric heating with RDX43.2

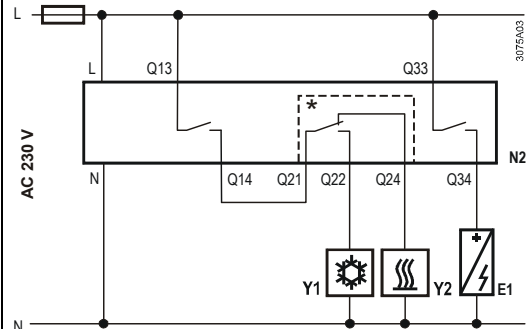
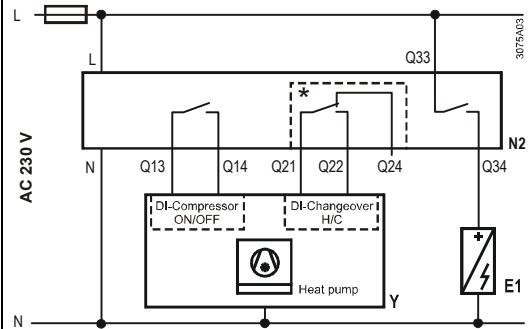

Legend

L	Live conductor AC 230 V	L	Live conductor AC 230 V
N	Neutral conductor AC 230 V	N	Neutral conductor AC 230 V
N1	Room temperature controller RDX33...	N2	Room temperature controller RDX43..
R1	Relay changeover module	E1	Auxiliary electric heating
Y	Heat pump	Y	Heat pump
Y1	Actuating device "Heating"	Y1	Actuating device "Heating"
Y2	Actuating device "Cooling"	Y2	Actuating device "Cooling"
Q13-Q14	Output for compressor	Q13-Q14	Output for compressor
Q21-Q22	H/C changeover output	Q21-Q22-Q24	H/C changeover output
*	AC 230 V or SELV DC 10 V	Q33-Q34	Output for auxiliary electric heating

Dimensions

